

SNOWPLOWS BROCHURE

REQUEST
QUOTE



**METAL
PLESS**

metalpless.com

MAXXPRO

Industrial snowplow with hydraulic wings and angle.
The **MAXXPRO** is installed on a wheel loader.

Model	Available Edges	Blade Dimensions			Application	Approx. Weight
		Box	Height	Extended		
PRO 0848-18	HD - LE	8'	48"	18'	25 000 lb and up	4 700 lb
PRO 0848-20	HD - LE	8'	48"	20'	25 000 lb and up	4 900 lb
PRO 1048-18	HD - LE	10'	48"	18'	25 000 lb and up	4 800 lb
PRO 1048-20	HD - LE	10'	48"	20'	25 000 lb and up	5 000 lb
PRO 1048-22	HD - LE	10'	48"	22'	25 000 lb and up	5 200 lb
PRO 1048-26	HD - LE	10'	48"	26' (van)	25 000 lb and up	5 900 lb
PRO 1248-20	HD - LE	12'	48"	20'	30 000 lb and up	5 200 lb
PRO 1248-22	HD - LE	12'	48"	22'	30 000 lb and up	5 400 lb
PRO 1248-24	HD - LE	12'	48"	24'	30 000 lb and up	5 600 lb
PRO 1248-28	HD - LE	12'	48"	28' (van)	30 000 lb and up	6 300 lb
PRO 1448-25	HD - LE	14'	48"	25'	35 000 lb and up	6 400 lb
PRO 1648-30	HD - LE	16'	48"	30'	40 000 lb and up	7 000 lb

Specs, models and/or model numbers are subject to change.

Model	Available Edges	Blade Dimensions			Application	Approx. Weight
		Box	Height	Extended		
PRO 2048-36	HD - LE	20'	48"	36'	50 000 lb and up	10 000 lb
PRO 2460-44	HD - LE	24'	60"	44'	60 000 lb and up	15 000 lb
PRO 3660-56	HD - LE	36'	60"	56'	70 000 lb and up	19 400 lb

Specs, models and/or model numbers are subject to change.



48"



Also available in

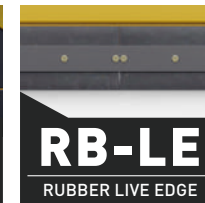

60"

Included:

- Angle and wing hydraulic systems
- Electric over hydraulic valves
- Quick coupler for industrial loader

- CCE standard on LE, optional on HD
- Curb runners

This system requires 1 set of oil outlets

Blade Positions



Options (Not included):

- Non standard color (NSC1)
- Electric valve and joystick (JSC3) 12 or 24 volts: electric over hydraulic 1 spool mounted on blade with electric control and necessary cable for the installation in the tractor cab.

The width of the blade does not determine the real dimension of the product. Pictures shown might have some options.

WHY SWITCH TO MAXXPRO?

#1 Efficiency

The **MAXXPRO** sets the industry standard in snowplow efficiency.

#2 Easy to Use

Operator-friendly level and slip hitch indicators make it easy to use.

#3 Strength

CHT-400 steel in the build reduces weight. Push snow not steel!

#4 Cost Savings

Carbide-infused LIVE EDGE gives incredible longevity and low maintenance costs.

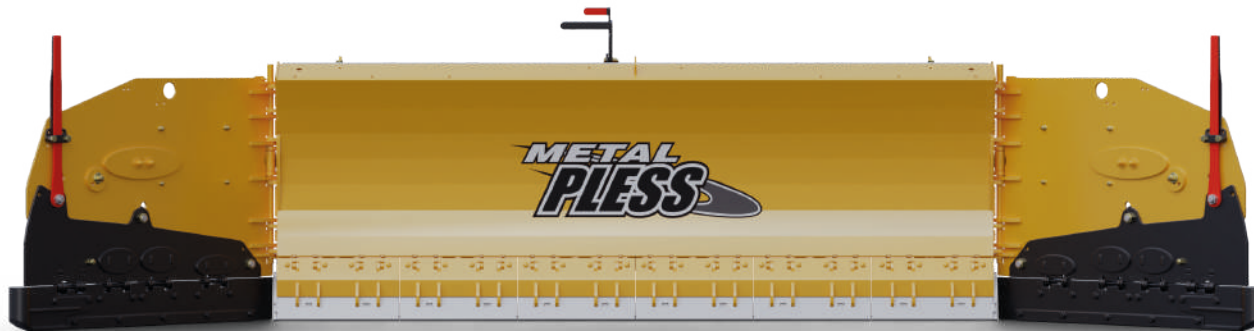

Not included:

- Hydraulic hoses and connectors from the blade to the vehicle



REQUEST QUOTE

EXPERT OPINION

“THE MOST ROBUST, MOST EFFICIENT AND COST EFFECTIVE PLOW IN THE WORLD!”

ONE MAXXPRO CAN DO THE WORK OF 2 TO 3 BOX PLOWS.

THIS PLOW ELIMINATES CAPITAL EXPENSE IN MACHINERY, LABOR COST, AND MONEY SPENT ON FUEL!

THIS MIGHTY PLOW WILL DO IT ALL FOR YOU.”

AGRIMAXX

Snowplow with hydraulic wings and angle.

The **AGRIMAXX** pusher is installed in front of a tractor with a universal subframe exclusive to Metal Pless.



Model	Available Edges	Blade Dimensions			Application	Approx. Weight
		Box	Height	Extended		
AGLT 0527-10	STD	5'	27"	10'	40-50 HP	982 lb
AGLT 0627-11	STD	6'	27"	11'	50-60 HP	1 100 lb
AGLT 0727-12	STD	7'	27"	12'	50-70 HP	1 165 lb
AGH 0630-11	STD - HD - LE	6'	30"	11'	65-80 HP	1 446 lb
AGH 0730-12	STD - HD	7'	30"	12'	65-80 HP	1 501 lb
AGH 0830-13	STD - HD - LE	8'	30"	13'	70-80 HP	1 556 lb
AGH 0736-13	HD - LE	7'	36"	13'	60-90 HP	1 868 lb
AGH 0836-14	STD - HD - LE	8'	36"	14'	80-100 HP	2 000 lb
AGH 0936-15	STD - HD - LE	9'	36"	15'	90-125 HP	2 110 lb
AGH 0836-16	HD - LE	8'	36"	16'	90-125 HP	2 200 lb
AGH 1036-16	STD - HD - LE	10'	36"	16'	100-125 HP	2 188 lb
AGH 1236-18	STD - HD - LE	12'	36"	18'	100-125 HP	2 380 lb
AGH 0842-15	HD - LE	8'	42"	15'	125 HP and up	2 427 lb
AGH 0842-16	HD - LE	8'	42"	16'	125 HP and up	2 502 lb
AGH 1042-17	HD - LE	10'	42"	17'	125 HP and up	2 582 lb
AGH 1242-19	STD - HD - LE	12'	42"	19'	125 HP and up	2 768 lb

Specs, models and/or model numbers are subject to change.

27"

30"

36"

42"



Also available in

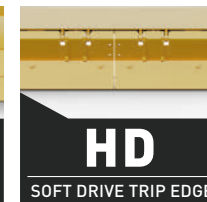
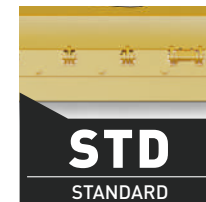

Included:

- Tractor subframe
- Angle and wing hydraulic systems

This system requires 4 sets of oil outlets

Options (Not included):

- Tire saver (PPLT or PP)
- Nitrogen accumulator package (AAC)
- 3/4" x 6" teflon cutting edge (TCE3/4)

- Electric valve and joystick (JSC4): electric over hydraulic 4 spools mounted on blade with electric control and necessary cable for the installation in the tractor cab.
- Electric hydraulic diverter valve 4 sets of oil outlets 12 volts (DVDE3 or DVDE4) 13 or 24 GPM to be specified

Blade Positions



The width of the blade does not determine the real dimension of the product. Pictures shown might have some options.

WHY SWITCH TO AGRIMAXX?

#1 Versatility

Allows you to use a farm tractor year round.

#2 Easy to Use

Versatile setup that gives you clear visibility and makes maneuvering effortless.

#3 Cost Savings

The universal subframe lets you switch plows between tractors easily, avoiding the cost of a new subframe.

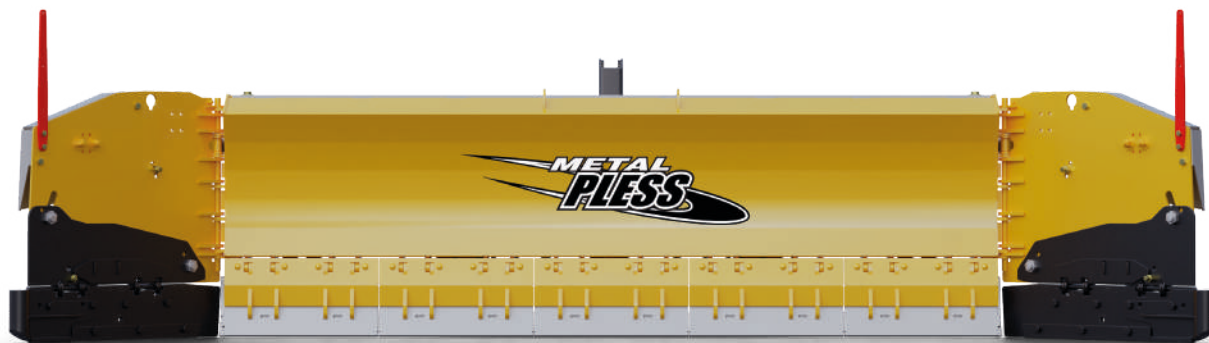

- Carbide cutting edge (CCE)
- Non standard color (NSC1)
- Curb runners (CR...)

Not included:

- Hydraulic hoses and connectors from the blade to the vehicle



REQUEST QUOTE

EXPERT OPINION

“THIS PLOW MAKES A FARM TRACTOR A **SNOWFIGHTER’S DREAM COME TRUE.**”

IT TURNS A MACHINE THAT WAS ONCE SLEEPING DURING THE WINTER MONTHS INTO A YEAR-ROUND MONEY MAKER.

ALONGSIDE ALL THE EXCEPTIONAL FEATURES THAT DEFINE METAL PLESS PLOWS, **IT ALSO INCLUDES A UNIVERSAL SUBFRAME THAT EFFORTLESSLY MOUNTS ON ANY TRACTOR.**

THE AGRIMAXX SUBFRAME SPREADS THE WEIGHT AND ANY POSSIBLE IMPACT FROM THE FRONT TO THE REAR OF THE TRACTOR, MAKING THIS PLOW SAFE AND EFFECTIVE TO USE.”

PLOWMAXX

Snowplow with hydraulic wings and angle.
The **PLOWMAXX** can be installed on a skid steer, backhoe or wheel loader.

Model	Available Edges	Blade Dimensions			Application	Approx. Weight
		Box	Height	Extended		
PLLT 04.527-8.5	STD	4'6"	27"	8'6"	6 000 lb max.	875 lb
PLLT 0527-10	STD	5'	27"	10'	6 000 lb max.	1 114 lb
PLLT 0627-11	STD	6'	27"	11'	6 000 lb max.	1 242 lb
PLLT 0727-12	STD	7'	27"	12'	6 000 lb max.	1 297 lb
PLSS 0630-11	STD - LE	6'	30"	11'	12 000 lb max.	1 640 lb
PLSS 0730-12	STD - HD	7'	30"	12'	12 000 lb max.	1 740 lb
PLSS 0830-13	STD - HD - LE	8'	30"	13'	12 000 lb max.	1 930 lb
PLBH 0736-13	HD - LE	7'	36"	13'	18 000 lb max.	2 107 lb
PLBH 0836-14	STD - HD - LE	8'	36"	14'	18 000 lb max.	2 250 lb
PLBH 0936-15	STD - HD - LE	9'	36"	15'	20 000 lb max.	2 340 lb
PLBH 0836-16	HD - LE	8'	36"	16'	20 000 lb max.	2 435 lb
PLBH 1036-16	STD - HD - LE	10'	36"	16'	20 000 lb max.	2 427 lb
PLBH 1236-18	STD - HD - LE	12'	36"	18'	20 000 lb max.	2 620 lb
PLLD 0842-15	HD - LE	8'	42"	15'	25 000 lb max.	2 842 lb
PLLD 0842-16	HD - LE	8'	42"	16'	25 000 lb max.	3 000 lb
PLLD 1042-17	HD - LE	10'	42"	17'	25 000 lb max.	3 205 lb
PLLD 1042-18	HD - LE	10'	42"	18'	25 000 lb max.	3 277 lb
PLLD 1242-19	STD - HD - LE	12'	42"	19'	25 000 lb max.	3 326 lb

Specs, models and/or model numbers are subject to change.



Also available in

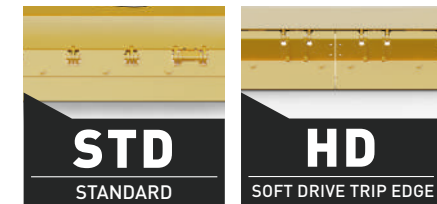

Included:

- Angle and wing hydraulic systems
- Electric over hydraulic valves

This system requires 1 set of oil outlets

Options (Not included):

- Quick coupler
- Carbide cutting edge (CCE)
- Curb runners (CR36-STD)

- CCE standard on LE, optional on HD/STD
- Curb runners standard on LE/HD, optional on STD

- Non standard color (NSC1)
- Electric valve and joystick (JSC3) 12 or 24 volts: electric over hydraulic 3 spools mounted on blade with electric control and necessary cable for the installation in the tractor cab.

Blade Positions



The width of the blade does not determine the real dimension of the product. Pictures shown might have some options.

WHY SWITCH TO PLOWMAXX?

#1 Robust

Robustly built but not too heavy for each machine. As the weight of the carrier unit goes up, the build strength of the **PLOWMAXX** increases. We want you to push snow, not steel.

#2 Versatility

For loaders and skid steers from 5,000, to 25,000 pounds, there is a model for every application.

#3 Compact

Ideal for smaller contracts or for working with a **MAXXPRO** in tighter areas.

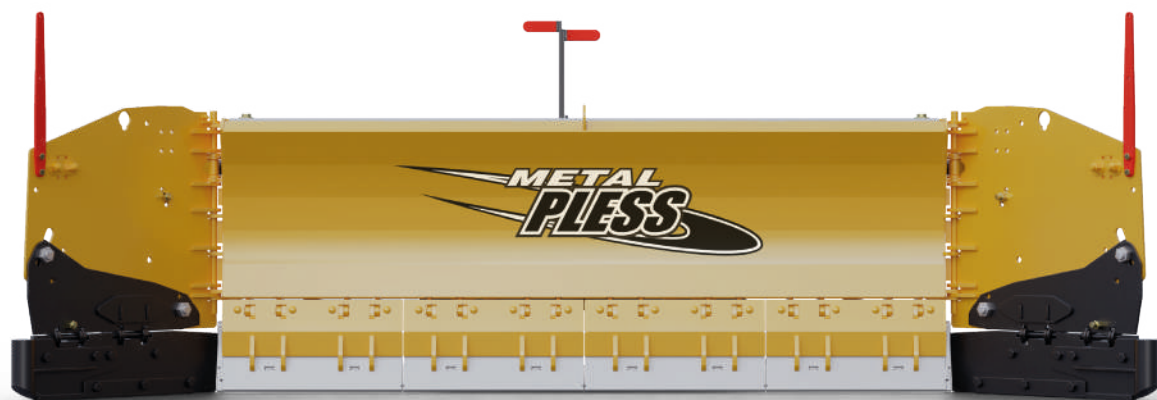

Not included:

- Hydraulic hoses and connectors from the blade to the vehicle



REQUEST
QUOTE

EXPERT OPINION

“NO MATTER WHAT SIZE YOUR FLEET IS, FROM 1 MACHINE TO 20, **THE PLOWMAXX IS A MUST HAVE DUE TO ITS VERSATILITY, BOTH IN SIZE OPTIONS AND CARRIER MACHINE APPLICATIONS.**”

GREAT FOR CLEANING CORNERS AND HARD TO REACH AREAS, OR FOR PLOWING A WHOLE LOT.

THE PLOWMAXX IS THE MULTI-TOOL EVERY SNOWFIGHTER NEEDS IN THEIR TOOLBOX.”

LIVEBOXX

Box plow with fixed wings and “LIVE EDGE” trip system. The **LIVEBOXX** pusher is installed on a skid steer, backhoe or wheel loader.

Model	Available Edges	Blade Dimensions		Side Gate Depth	Application	Approx. Weight
		Width	Height			
LBX 0832	LE	8'	32"	36"	18 000 lb max.	1 345 lb
LBX 1032	LE	10'	32"	36"	18 000 lb max.	1 550 lb
LBX 1232	LE	12'	32"	36"	18 000 lb max.	1 760 lb
LBX 1236	LE	12'	36"	36"	24 000 lb max.	1 935 lb
LBX 1042	LE	10'	42"	42"	50 000 lb max.	2 250 lb
LBX 1242	LE	12'	42"	42"	50 000 lb max.	2 565 lb
LBX 1442	LE	14'	42"	42"	50 000 lb max.	2 805 lb
LBX 1642	LE	16'	42"	42"	50 000 lb max.	3 045 lb
LBX 1842	LE	18'	42"	42"	50 000 lb max.	3 285 lb
LBX 2042	LE	20'	42"	42"	50 000 lb max.	3 525 lb
LBX 1248	LE	12'	48"	48"	45 000 lb +	2 615 lb
LBX 1448	LE	14'	48"	48"	45 000 lb +	3 305 lb
LBX 1648	LE	16'	48"	48"	45 000 lb +	3 545 lb
LBX 1848	LE	18'	48"	48"	45 000 lb +	3 785 lb
LBX 2048	LE	20'	48"	48"	45 000 lb +	4 025 lb

Specs, models and/or model numbers are subject to change.

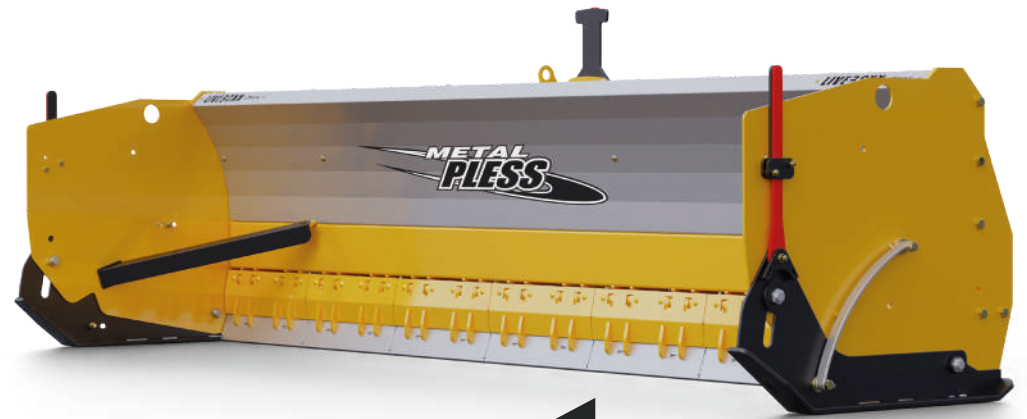

32"
36"
42"
48"

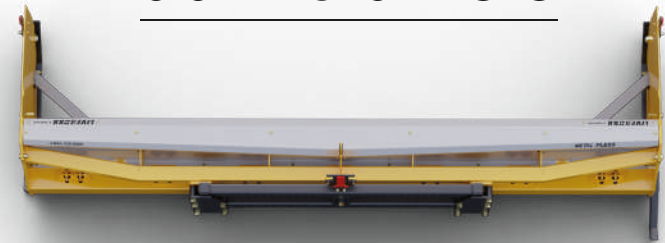

Some assembly is required from transportation mode to work mode.

Blade Positions



Options (Not included):

- Quick coupler
- Bucket mount
- Non standard color (NSC1)

The width of the blade does not determine the real dimension of the product. Pictures shown might have some options.

WHY SWITCH TO LIVEBOXX?

#1 Superior Quality

The best-built box plow in the industry.

#3 Easy to Use

The level and slip hitch indicators are designed to be user-friendly, making it easy for you to operate.

#2 Cost Savings

Carbide-infused LIVE EDGE gives incredible longevity and low maintenance costs.

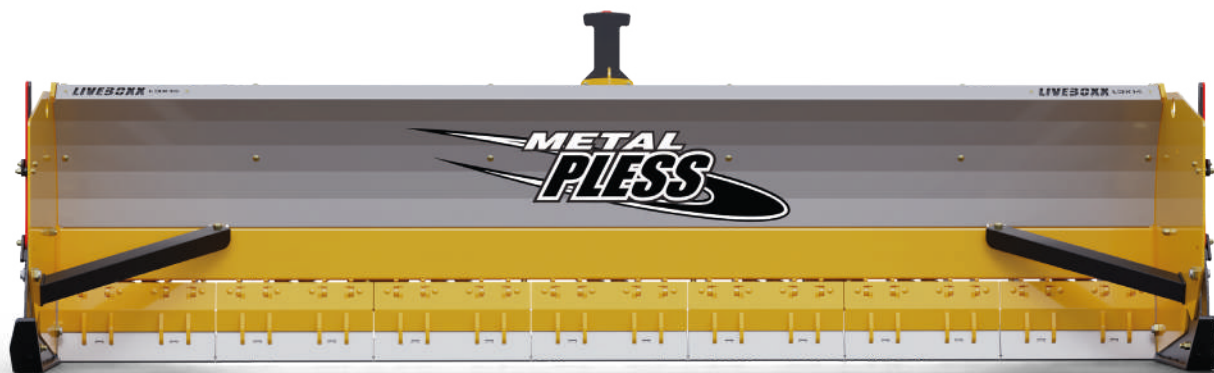

REQUEST
QUOTE

EXPERT OPINION

“THE LIVEBOXX IS A MUST HAVE IN EVERY SNOWFIGHTER’S FLEET DUE TO ITS EASE OF USE AND THE LONGEVITY OF ITS CUTTING EDGES.

AVAILABLE FROM 8 TO 20 FEET WIDTHS, THERE IS ONE FOR JUST ABOUT ANY CARRIER OUT THERE. SIMPLE, EASY TO USE, BUT AT THE SAME TIME VERY EFFICIENT.

ALL LIVEBOXX COME EQUIPPED WITH OUR LIVE EDGE CUTTING EDGE, AN OSCILLATING SLIP HITCH WITH A SLIP HITCH INDICATOR, AND LEVEL INDICATORS ON THE WINGS. IT IS THE MOST ADVANCED AND YET THE EASIEST BOX PLOW AVAILABLE WORLDWIDE. ”

RUBBERMAXX

Snowplow with rubber cutting edge. It can be installed with or without angulation. The **RUBBERMAXX** can be installed on agricultural loader "arms", skid steers, backhoes or on the front of a tractor with a Universal Subframe exclusive to Metal Pless.

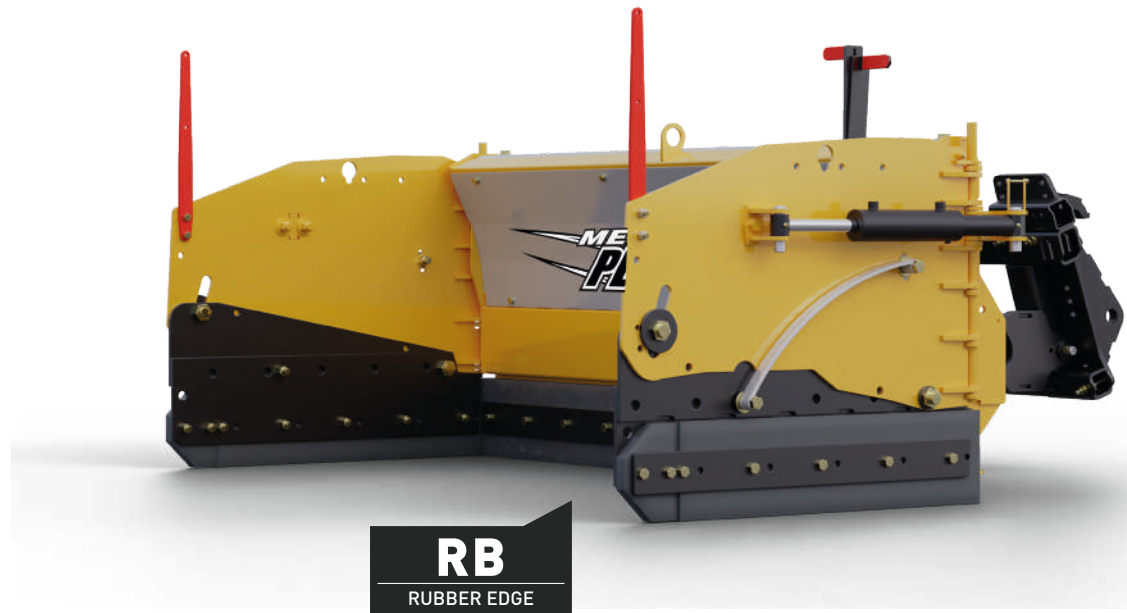

Model	Available Edges	Blade Dimensions			Application	Approx. Weight
		Box	Height	Extended		
RBX 0626-11	RB	6'	26"	11'	40-60 HP	900 lb
RBX 0730-13	RB	7'	30"	13'	50-80 HP	1 350 lb
RBX 0736-14	RB	7'	36"	14'	60-90 HP	1 450 lb
RBX 0836-15	RB	8'	36"	15'	90-125 HP	1 550 lb

Specs, models and/or model numbers are subject to change.

Possible configurations:

- Without angulation (**REVERSEMAXX**) includes DVDE2, 12 volts, 13 GPM.
- With angulation (**PLOWMAXX**) includes DVDE3, 12 volts, 13 GPM.
- With angulation and subframe (**AGRIMAXX**).

Included:

- Angle and wing hydraulic systems (*This feature is only available on certain models)
- Electric over hydraulic valves (*This feature is only available on certain models)

Options (**Not included**):

- Quick coupler
- Nitrogen accumulator package installed on the lift cylinder (AAC) (AgriMaxx)
- Non standard color (NSC1)
- 3 point hitch attachment (A3P)

Blade Positions



The width of the blade does not determine the real dimension of the product. Pictures shown might have some options.

WHY SWITCH TO RUBBERMAXX?

#1 Non-Abrasive

Gentle on delicate surfaces like pavers and stamped concrete.

#2 Robust

The rubber compound has a high degree of hardness and is made exclusively for Metal Pless.

#3 Lasting

Lasts longer than Teflon. The rubber edge is flexible for increased life wear.

#4 Versatility

All the features of a **PLOWMAXX** or **AGRIMAXX**.

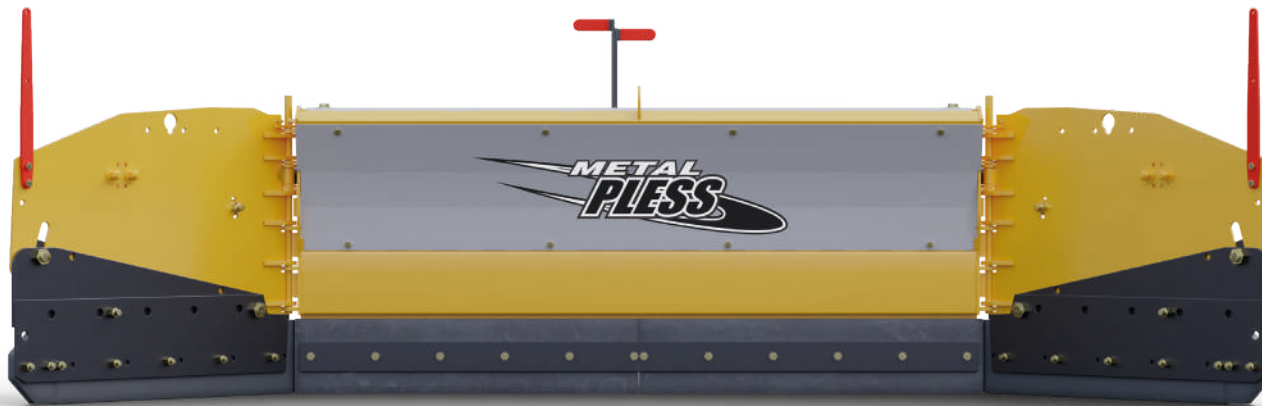

Not included:

- Hydraulic hoses and connectors from the blade to the vehicle



REQUEST QUOTE

EXPERT OPINION

“A MUST FOR DELICATE SURFACES. THE RUBBER EDGE WILL NOT DAMAGE PAVERS OR STAMPED CONCRETE.”

THE RUBBERMAXX IS EQUIPPED WITH A HARD, LONG-LASTING RUBBER COMPOUND THAT WILL LAST MANY SEASONS, WHILE AT THE SAME TIME WILL CLEAN RIGHT DOWN TO THE SURFACE.”

REVERSEMAXX

Snowplow with hydraulic wings, without angulation.
The **REVERSEMAXX** is installed on an agricultural loader "arms", skid steer or backhoe.

Model	Available Edges	Blade Dimensions			Application	Approx. Weight
		Box	Height	Extended		
REVL 0527-10	STD	5'	27"	10'	35-45 HP	1 000 lb
REVL 0627-11	STD	6'	27"	11'	45-55 HP	1 130 lb
REVL 0727-12	STD	7'	27"	12'	55-65 HP	1 185 lb
REVM 0630-11	STD - LE	6'	30"	11'	50-60 HP	1 398 lb
REVM 0730-12	STD - HD	7'	30"	12'	60-80 HP	1 498 lb
REVM 0830-13	STD - HD - LE	8'	30"	13'	70-90 HP	1 688 lb
REVM 0736-13	HD - LE	7'	36"	13'	60-90 HP	1 865 lb
REVM 0836-14	HD - LE	8'	36"	14'	80-100 HP	2 000 lb
REVM 0936-15	STD - HD - LE	9'	36"	15'	90-125 HP	2 100 lb
REVM 0836-16	STD - HD - LE	8'	36"	16'	85-125 HP	2 200 lb
REVM 1036-16	STD - HD - LE	10'	36"	16'	100-125 HP	2 185 lb
REVM 1236-18	STD - HD - LE	12'	36"	18'	125 HP and up	2 378 lb

Specs, models and/or model numbers are subject to change.



HD
SOFT DRIVE TRIP EDGE

27"

30"

36"



Also available in

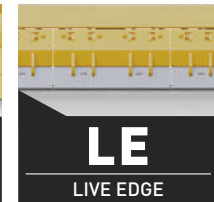
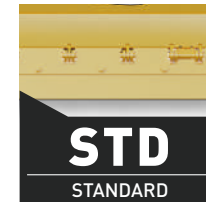

Included:

- Wing hydraulic systems
- Electric over hydraulic valves

Options (Not included):

- Quick coupler
- Carbide cutting edge (CCE)

- Non standard color (NSC1)
- Teflon cutting edge $\frac{3}{4}$ " x 6" (TCE $\frac{3}{4}$)

Blade Positions



The width of the blade does not determine the real dimension of the product. Pictures shown might have some options.

WHY SWITCH TO REVERSEMAXX?

#1 Protection

Increased protection of the loader arms on your tractor.

#2 Versatility

All the benefits of a **PLOWMAXX** without the angulation.

#3 Close fit

Fits very close to the quick coupler, offering increased visibility for the operator.



Not included:

- Hydraulic hoses and connectors from the blade to the vehicle



REQUEST
QUOTE

EXPERT OPINION

“**DESIGNED FOR TRACTOR LOADER ARMS,**

IT IS **SAFE AND EFFICIENT TO USE ON AGRICULTURAL LOADER ARMS,**

WITHOUT THE RISK OF BENDING THE ARMS OR DAMAGING YOUR TRACTOR.”

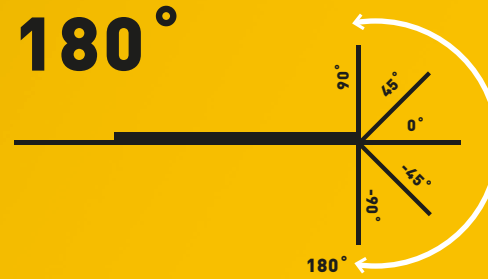

HYDRAULIC WINGS

Our wings are constructed with CHT400 steel, making them the strongest in the industry. We use cylinders to move the wings, instead of actuators (hydraulic motors), offering superior holding strength. The leverage is increased by having two cylinders per wing. Additionally, the wings are equipped with a spring that can be adjusted to provide down pressure.

SOFT DRIVE TRIP EDGE

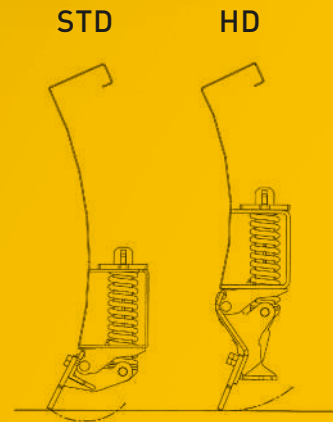

Unique Soft Drive Trip Edge design allows the individual sections to trip backward without the blade being lifted upward, greatly reducing the impact.



HD

SOFT DRIVE TRIP EDGE



Curb runner

TRIP EDGE ON THE WINGS

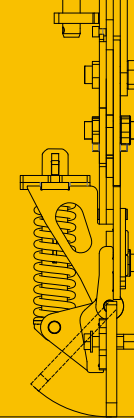

Available on HD and LIVE EDGE models. The bottom part of the wing can trip if an obstacle is struck.

The cutting edge can trip without creating an impact on the motorized vehicle. Safer for the operator and reduces damage to equipment!

LATERAL & VERTICAL FLOAT

Automatically follows the imperfections of the pavement. Our system incorporates an adjustable oscillating mechanism for better control.

Increase plowing efficiency and no need to go over the same area multiple times.

Slip hitch design allows the plow to follow surface variations. Reduces operator fatigue and increases plowing efficiency. Cutting edges wear evenly and prolong plow life.



TRUCKMAXX

Snowplow for 10 or 12 wheel trucks.
The **TRUCKMAXX** is ideal for roadways and highways.

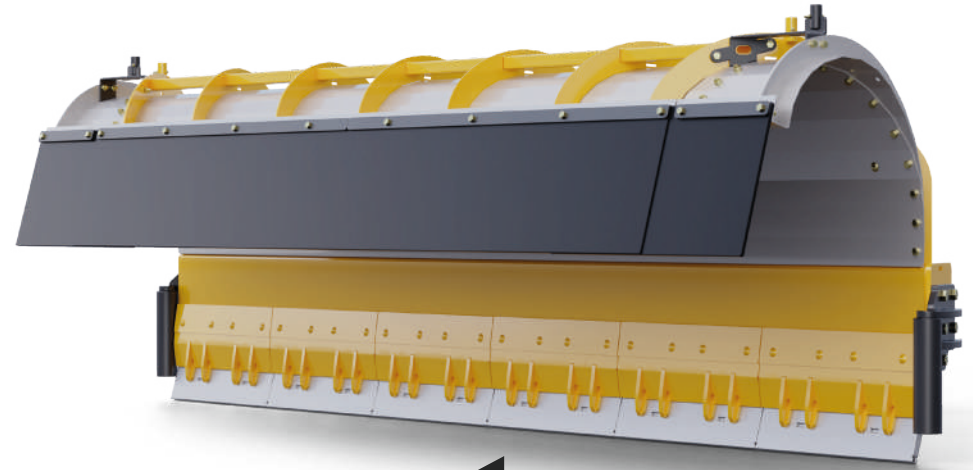

Model	Available Edges	Front blade		Side wing STD		Application	Approx. Weight
		Box	Height	Box	Height		
TRK 10-08	HD - LE	10'	30"	8'	30"	F550, F650 or equivalent	-
TRK 10-09	HD - LE	10'	30"	9'	30"	F550, F650 or equivalent	-
TRK 12-10	HD - LE	12'	42"	10'	36"	10 Wheel truck	-
TRK 12-11	HD - LE	12'	42"	11'	36"	10 Wheel truck	-
TRK 12-12	HD - LE	12'	42"	12'	36"	10 Wheel truck	-
TRK 12-14	HD - LE	12'	42"	14'	36"	10 or 12 Wheel truck	-
SOLD AS MAIN BLADE ONLY (without harness)							
TRK 11LE	LE	11'	42"	-	-	10 Wheel truck	2 467 lb
TRK 12LE	LE	12'	42"	-	-	10 Wheel truck	2 720 lb
TRK 14LE	LE	14'	42"	-	-	10 Wheel truck	2 986 lb
SOLD AS SIDE WING ONLY (without harness)							
TRKSW 10LE	STD - LECCT	-	-	10'	36"	10 Wheel truck	-
TRKSW 12LE	STD - LECCT	-	-	12'	36"	10 Wheel truck	-
TRKSW 14LE	STD - LECCT	-	-	14'	36"	10 Wheel truck	-

Specs, models and/or model numbers are subject to change.

LE
LIVE EDGE

On main blade



Also available in

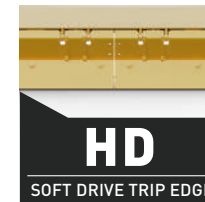

On main blade

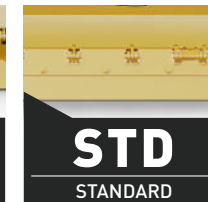

On side wing



On side wing

42"

36"

Included:

- Includes HS on main blade (high speed, accentuated curve of the mouldboard)
- Angular System

- CCE standard on LE, optional on HD

Options (Not included):

- Carbide cutting edge (CCE)
- Nitrogen accumulator package installed on the lift cylinder (AAC)

- Inter-acting LIVE EDGE (LECCT)
- Non standard color (NSC1)

Blade Positions



WHY SWITCH TO TRUCKMAXX?

#1 Traction

A municipal favorite. Gets the roads down to blacktop, giving your truck more traction.

#2 Eco-Friendly

The LIVE EDGE helps reduce salt consumption by 50%, clearing the way to a safer environment.

#3 Robust

Designed for Municipalities with its robust construction.

#4 Essential

Reduce operator fatigue and equipment stress with LIVE EDGE and soft trip mechanisms.

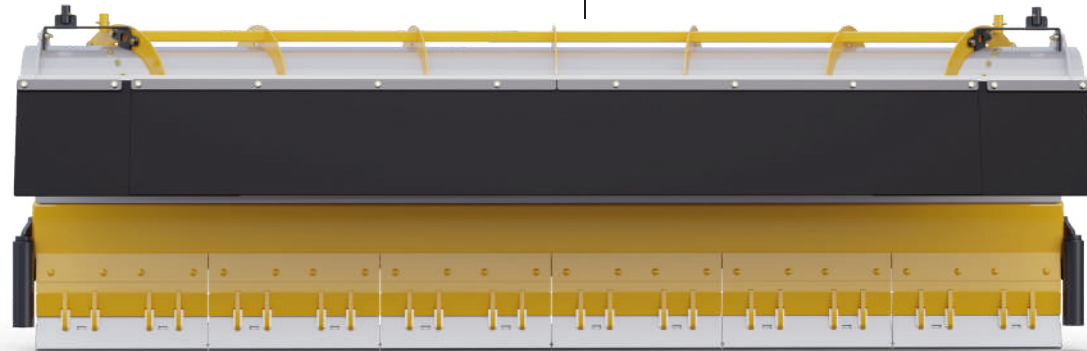

Not included:

- Hydraulic hoses and connectors from the blade to the vehicle

EXPERT OPINION

“A HEAVY-DUTY TRUCK PLOW THAT, WHEN EQUIPPED WITH OUR LIVE EDGE, CAN REDUCE SALT USE BY UP TO 50%.”

ALREADY IN USE IN MANY NORTH AMERICAN MUNICIPALITIES, THIS PLOW GETS THE SNOW DOWN TO THE ASPHALT IN ONE PASS, GIVING THE TRUCK MUCH BETTER TRACTION.

BOTH THE TRUCK AND OPERATOR FEEL LESS VIBRATION, CREATING A HEALTHIER WORK ENVIRONMENT AND LOWERING MAINTENANCE COSTS.

THERE ARE SAVINGS IN SALT, FUEL, AND SPRING CLEAN-UP OF LEFT-OVER ABRASIVES.

IT IS ALSO MUCH BETTER FOR THE ENVIRONMENT (LESS EMISSIONS AND SALT)”



REQUEST QUOTE

SIDEMAXX

Sidewalk blade with hydraulic angle.
The **SIDEMAXX** can be installed on sidewalk specialty vehicles or tractors.

Option 1: Heavy duty 18" hydraulic extension.

Option 2: Tilt 12" hydraulic pivot from up/down (requires hydraulic float).

Option 3: 14" hydraulic sideshift (5" to the left and 9" to the right).

Possible options configuration: 1 & 2 / 2 & 3 / 1, 2 & 3.

An additional set of oil outlets is needed per option.

Available with :

- 3 point hitch (category 2)
- Hitch also compatible with Wacker, Trackless, SW48, Multihog etc.
- Tractor subframe

Model	Available Edges	Blade Dimensions		Application	Approx. Weight
		Width	Height		
SM 527/60	STD	60"	27"	35 HP and up	550 lb
SM 530/60LE	LE	60"	30"	35 HP and up	725 lb

Specs, models and/or model numbers are subject to change.



Also available in

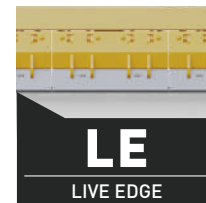

Included:

- Angular system

This system requires 1 set of oil outlets

Options (Not included):

- Carbide cutting edge (CCE)
- Non standard color (NSC1)
- Joystick and valve (DVDE2)

Blade Positions



Not included:

- Hydraulic hoses and connectors from the blade to the vehicle

The width of the blade does not determine the real dimension of the product. Pictures shown might have some options.

SIDEMAXX

SIDEMAXX-X

Sidewalk blade with 6 hydraulic positions. The **SIDEMAXX-X** can be installed on specialty sidewalk vehicles or a tractor.

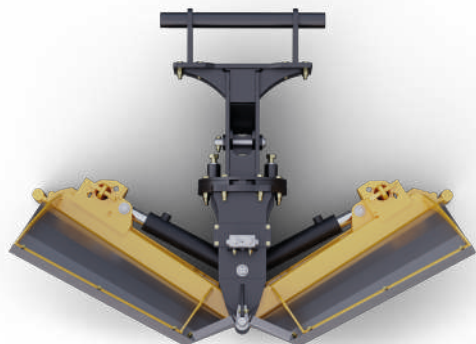

SIDEMAXX-X

Available with:

- 3 point hitch (category 1&2)
- Trackless coupler
- Tractor subframe



Model	Available Edges	Blade Dimensions			Application	Approx. Weight
		Straight	Front & rear "V"	Height		
SDX 532	STD	60"	48"	32"	35 HP and up	550 lb

Specs, models and/or model numbers are subject to change.



Included:

- Angular system
- This system requires 3 sets of oil outlets

Options (Not included):

- Carbide cutting edge (CCE)
- Non standard color (NSC1)
- Electric hydraulic diverter valve 3 sets of oil outlets 12 volts (DVDE3) 13 or 24 GPM to be specified.

Blade Positions

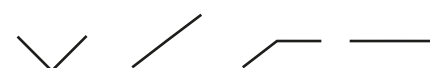

Not included:

- Hydraulic hoses and connectors from the blade to the vehicle

The width of the blade does not determine the real dimension of the product. Pictures shown might have some options.

LIVE EDGE

PATENTED TECHNOLOGY

METAL PLESS
LIVE EDGE
Technology

LE

LIVE EDGE

**FOLLOWS
AND CONTOURS
the imperfections
of roadways**

METAL PLESS “LIVE EDGE” technology.

Our cutting-edge technology allows our snowplow to adapt to effortlessly road and lot imperfections, ensuring complete surface contact for optimal cleaning.

This innovation accelerates surface clearing and enhances safety on roads and parking lots while significantly reducing the need for salt and abrasives.

“LIVE EDGE” sets a new standard in advanced snowplow technology.

MIX AND MATCH YOUR EQUIPMENT WITH OUR NON STANDARD COLORS

The powder coat process will help keep your plow looking great for years!

Equipment looks cleaner and keeps its resale value! Reduces maintenance.

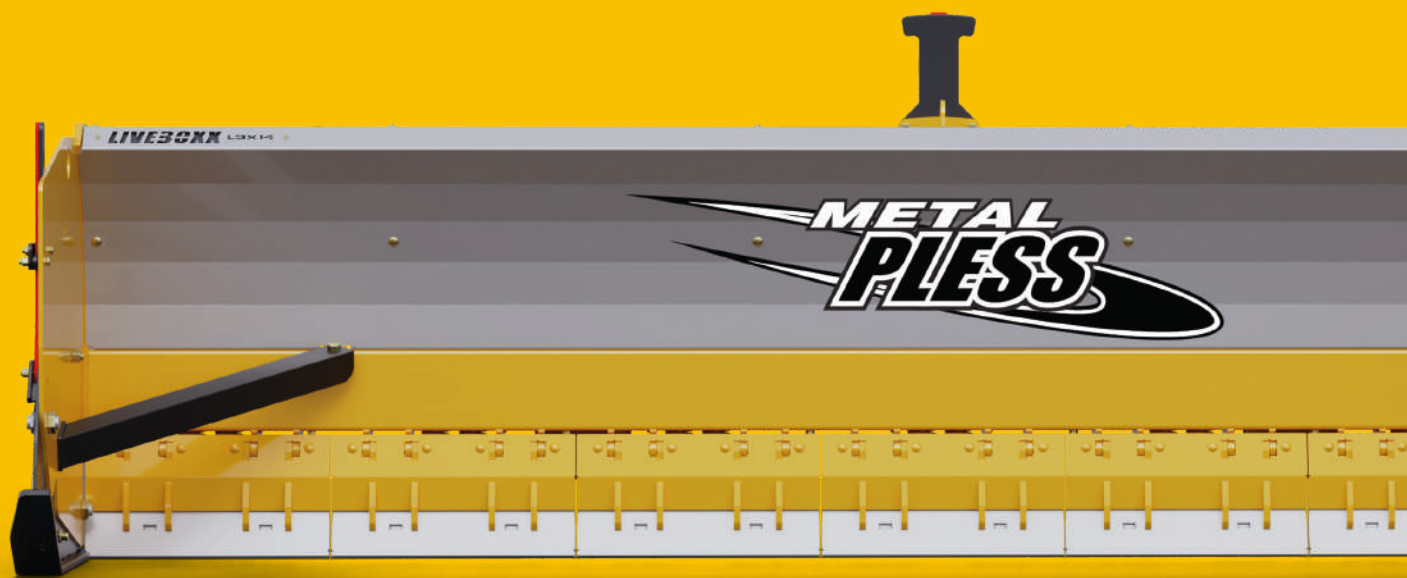

CITYMAXX

- Hydraulic wings
- Hydraulic angle
- Subframe



EXTENDMAXX

- Extendable plow
- Hydraulic wings
- Hydraulic angle
- Subframe



EXTENDMAXX^{HD}

- Extendable plow
- Hydraulic wings
- Hydraulic angle



EXTENDMAXX^{EX4}

- Extendable plow
- Fixed wings



INVERSEMAXX

- Extendable plow
- Rotating side wings
- Parallel lift subframe



MAXXEDGE^{MINI}

- Fixed wings
- Offered with a trip system



JR PLOWMAXX

- Hydraulic angle

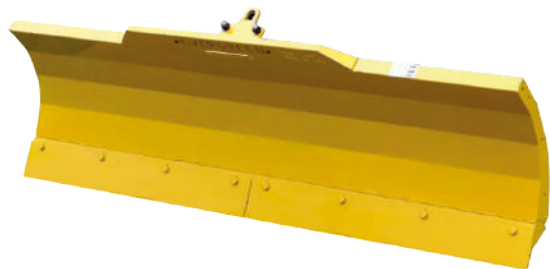

MINI PUSHERMAXX

- Fixed wings
- No trip system



R3MAXX

- Extendable plow
- Reversible plow
- Full tripping system of the blade



VMAXX

- Hydraulic angle
- Hydraulic tilt

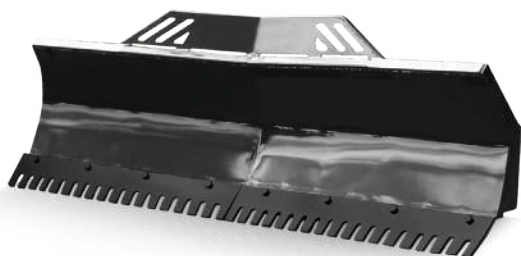

WINGMAXX

- Front blade with side wing
- Hydraulic angle

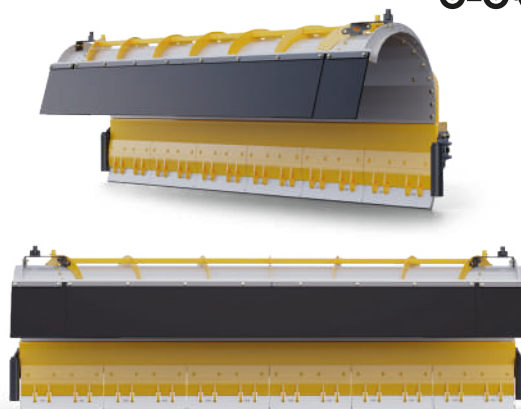

NEW
PLOWMAXX

IT'S ALL ABOUT THE **EDGE**

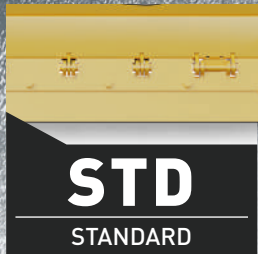

Standard trip edge allows cutting edge to trip back.

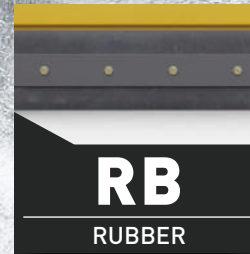

Rubber edges are flexible, tough, and quiet, and at same time less likely to damage delicate surfaces.

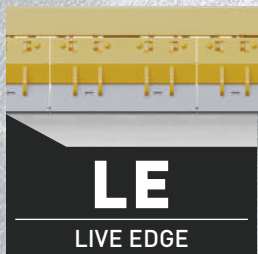

A floating soft drive steel trip edge with carbide inserts for longer wear life, that contours the unevenness of the ground for a cleaner result.



Individual floating rubber edge contouring the unevenness of the ground for a cleaner result while protecting delicate surfaces.

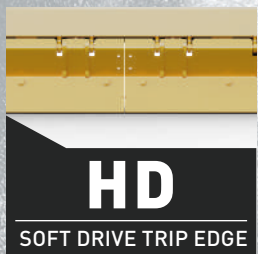

Unique Soft Drive trip edge design allows the individual sections to trip backward without the blade being lifted upward, greatly reducing the impact.



Inter-acting LIVE EDGE for hydraulic side wings. The serpentine-like movement allows the cutting edge to follow the surface being cleaned without risk of damaging the cutting edges or the area it is riding on.